

PRODUCT SHEET

Description:

Box Castor $\varnothing 25\text{mm}$, 19x42mm Bracket, BZP, MH 28mm, Grey PU Tyre & Black PP Core

Item number:

08.06.040-0

Units	Box	Carton	HS Code	Barcode
Pcs.	1	500	8302200090	
				5704866104470

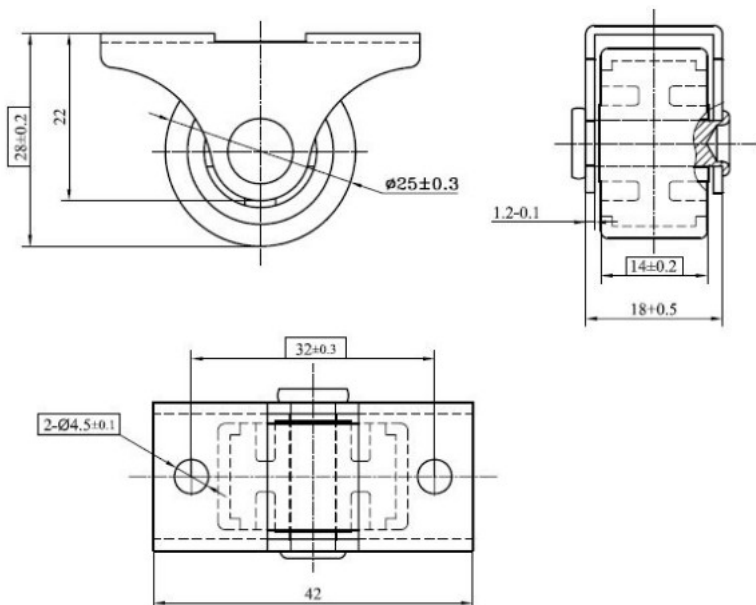

SISO A/S

Mileparken 11
DK-2740 Skovlunde
Denmark
VAT: DK 24786013

Phone +45 45 830 900

www.siso.dk
siso@siso.dk

Danske Bank
Nytorv Branch
Copenhagen
SWIFT: DABADKKK

Account no.
4180 3112 112936
IBAN Account
DK7230003112112936